



LDF - Lincat Lynx 400 Electric Counter-top Single Tank General Purpose Fryer - 1 Basket - W 270 mm - 3.0 kW

The 3kW Lynx 400 Electric Counter Top Fryer is designed to plug in and play, which means that you'll be producing perfect fried chips in no time at all.

- ✓ Removable control head to aid easy cleaning and maintenance
- ✓ Thermostatically controlled to give better and more consistent cooking results
- ✓ Safety thermostat to prevent overheat
- ✓ Stainless steel tanks for easy cleaning
- ✓ Comes with batter plate to allow open frying
- ✓ Nickel plated baskets for easy cleaning
- ✓ Plug and play for an easy installation

Specifications

Summary

Brand	Lincat
Range	Lynx 400
Power Type	Electric
Unit Type	Counter-top
Available in UK Only	No
UK Warranty	2 Years Parts and Labour Warranty
Export Warranty	Contact your local dealer
GTIN	5056105101024

Power and Performance

Total Power kW	3.0
Temperature Range °C	130-190
IP Rating	IP23
Temperature Control	Mechanical

Key Specifications

Number of Baskets	1
Number of Tanks	1
Gravity Filtration	No
Pumped Filtration	No

Capacity

Product Output per Hour	8kg chips - 12mm [frozen], 11kg chips - 12mm [chil]
Capacity Litres	4.0

Weights and Dimensions

Unit Height (External) mm	315
Unit Width (External) mm	270
Unit Depth (External) mm	417
Net Weight Kg	8

Supply Connections

Requires Installation	No
Requires Electrical Supply	Yes
UK 3 Pin Plug	Yes
Requires Hardwiring	No
Electrical Supply Rating Watts	3,000
Single Phase Amps	13.0
Single Phase Voltage	230

Shipping

Packed Weight Kg	13
Packed Height cm	42
Packed Width cm	48
Packed Depth cm	38

Technical Picture

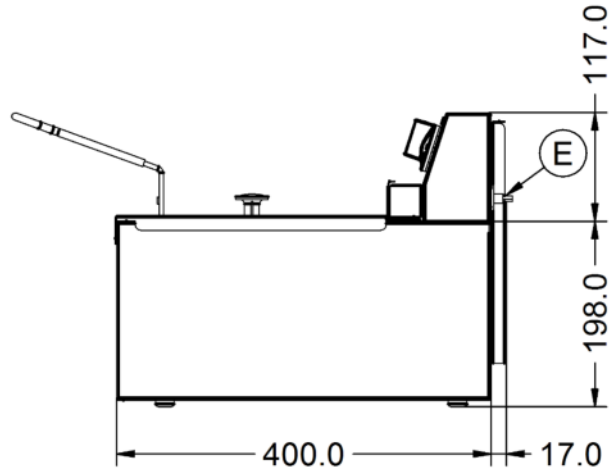
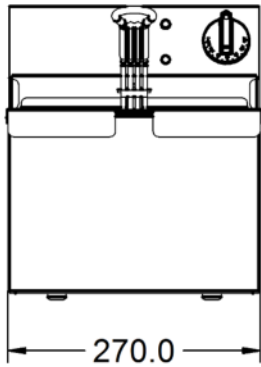
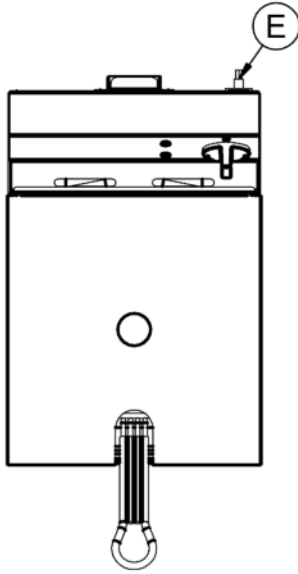

Lincat Limited

Whisby Road,
Lincoln, LN6 3QZ,
United Kingdom

Company No: 2175448

A member company of



Customer Care

Tel: +44 1522 875500
Email: care@lincat.co.uk

Export Customers

Tel: +44 1522 503250
Email: export@lincat.co.uk

Opening Hours

Monday – Friday:
8.30am – 5pm